



## **INSTRUCTION MANUAL**

**SONAMP® MULTI-CHANNEL POWER AMPLIFIERS  
2-100 & 12-50**

# INSTRUCTION MANUAL

## SONAMP® 2-100 & SONAMP® 12-50 MULTI-CHANNEL POWER AMPLIFIERS



### Important Safety Information

You should always follow these basic safety precautions when using your Sonamp 2-100 or Sonamp 12-50, to reduce the risk of fire, electric shock, and injury to persons:

1. **Read and retain instructions:** Read all the safety and operating instructions before operating the amplifier, and retain them for future reference.
2. **Heed warnings:** Adhere to all warnings and precautions listed on the amplifier and in the operating instructions.
3. **Follow instructions:** Follow all operating instructions.
4. **Water:** Never use the amplifier next to water.
5. **Carts and stands:** The amplifier should be used only with a cart or stand that is recommended by the manufacturer. An amplifier and cart combination should be moved with care. 
6. **CAUTION: TO PREVENT ELECTRIC SHOCK, DO NOT USE THE POLARIZED PLUG WITH AN EXTENSION CORD, RECEPTACLE, OR OTHER OUTLETS UNLESS THE BLADES CAN BE FULLY INSERTED TO PREVENT BLADE EXPOSURE.**
7. **Ventilation:** Situate the amplifier so that its location does not interfere with its proper ventilation.
8. **Heat:** Situate the amplifier away from heat sources such as radiators, stoves, or other appliances (including amplifiers) that produce heat.
9. **Grounding or polarization:** Grounding or polarization are precautions that should be taken so that these attributes are not defeated.
10. **Power-Cord Protection:** Route power supply cords so that they will not be walked on or pinched by items placed on or against them.
11. **Cleaning:** To clean the amplifier, use "canned air" or wipe the amplifier with a soft cloth. Do not use solvents, as they may damage the amplifier.
12. **Non-Use Periods:** Unplug the amplifier's power cord from the outlet when the amplifier will be left unused for a long period of time.
13. **Object Entry:** Care should be taken so that objects do not fall through the opening of the enclosure.
14. **Moisture:** Do not expose the amplifier to dripping or splashing. Do not place objects filled with liquids, such as vases, on the amplifier.
15. **Damage Requiring Service:** Have the amplifier serviced by a qualified service personnel when:
  - The power supply cord or the plug has been damaged.
  - Objects have fallen, or liquid has been spilled into the amplifier.

- The amplifier has been exposed to rain.
  - The amplifier does not appear to operate normally or exhibits a marked change in performance.
  - The amplifier has been dropped, or the enclosure damaged.
16. **Servicing:** The user should not attempt to service the appliance beyond that described in the operating instructions. All other servicing should be referred to qualified service personnel.
  17. **Lifting:** Improper lifting of the 20 lbs. 12-50 amp can cause personal injury. The 2-100 amp is only 10 lbs.
  18. **Power requirement:** Do not connect the Sonamp to the accessory outlet of any other component. A minimum 15 amp (20 amp preferred) grounded wall outlet is required.

**WARNING: THE POWER (MAINS) PLUG SERVES AS THE AMPLIFIER'S DISCONNECT DEVICE. THE DISCONNECT DEVICE SHALL REMAIN READILY OPERABLE DURING OPERATION. TO ENSURE THAT THE DISCONNECT DEVICE (POWER PLUG) IS EASILY ACCESSIBLE, THE USER SHALL NOT PLACE THE AMPLIFIER IN A CONFINED AREA DURING OPERATION.**

19. **Storms:** To prevent damage to components, unplug all electronic equipment during thunderstorms.



CAUTION: TO REDUCE THE RISK OF ELECTRIC SHOCK, DO NOT REMOVE COVER (OR BACK) NO USER SERVICEABLE PARTS INSIDE REFER SERVICING TO AUTHORIZED SERVICE PERSONNEL.



The lightning flash with arrowhead symbol, within an equilateral triangle, is intended to alert the user to the presence of uninsulated dangerous voltage within the product's enclosure that may be of sufficient magnitude to constitute a risk of electric shock to persons.



The exclamation point within an equilateral triangle is intended to alert the user to the presence of important operating and maintenance (servicing) instructions in the literature accompanying the appliance.

**WARNING:** TO PREVENT FIRE OR SHOCK HAZARD, DO NOT EXPOSE THIS APPLIANCE TO RAIN OR MOISTURE. THE APPLIANCE SHALL NOT BE EXPOSED TO DRIPPING OR SPLASHING. NO OBJECTS FILLED WITH LIQUIDS, SUCH AS VASES, SHALL BE PLACED ON THE APPLIANCE.

# INSTRUCTIONS IMPORTANTES CONCERNANT LA SÉCURITÉ

1. Lisez soigneusement ces instructions.
2. Conservez-les en lieu sûr pour toute référence future.
3. Respectez scrupuleusement tous les avertissements de sécurité.
4. Suivez toutes les instructions indiquées.
5. Ne pas utiliser cet appareil près de l'eau.
6. Nettoyez cet appareil uniquement avec un chiffon sec.
7. Ne jamais obstruer ses ouïes de ventilation. Installez cet appareil suivant les instructions recommandées par son fabricant.
8. Ne jamais installer cet appareil près d'une source de chaleur, comme les radiateurs, bouches de chaleur, fours et tout autre appareil (y compris les amplificateurs de puissance) générant de la chaleur.
9. Ne jamais démonter la prise polarisée ou la broche de mise à la terre de la prise secteur. Une prise polarisée possède deux lames, l'une étant plus large que l'autre (standard américain). Une prise avec mise à la terre possède trois broches, dont une centrale déportée par rapport aux deux autres. Ces différents brochages ont été conçus pour votre sécurité. Si la prise de l'appareil ne rentre pas dans la prise d'alimentation secteur de votre installation, veuillez consulter un électricien agréé pour le remplacement de la prise murale (certainement pas aux normes actuelles).
10. Protégez le câble d'alimentation secteur de telle manière qu'il ne puisse pas être écrasé ou pincé, particulièrement au niveau des prises, du passage dans des goulettes prévues à cet usage, ou à l'endroit où il sort de l'appareil.
11. N'utilisez que les systèmes de fixation et accessoires prévus et conseillés par le fabricant.
12. N'utilisez que des tables, supports, pieds, bras de fixation prévus ou conseillés par le fabricant, ou vendus avec l'appareil. Si un support mobile est utilisé, toujours procéder avec une grande précaution lors du déplacement de ce support afin d'éviter que l'appareil ne tombe et puisse blesser physiquement une personne.
13. Débranchez complètement l'appareil pendant un orage ou une longue période de non-utilisation.
14. Pour toute intervention sur l'appareil, adressez-vous exclusivement à du personnel qualifié et agréé. Une intervention avérera nécessaire si l'appareil a été endommagé, pour quelque raison que ce soit, et par exemple si le câble d'alimentation secteur ou sa prise sont endommagés, si du liquide a pénétré à l'intérieur de l'appareil, ou un objet y est tombé, ou bien si l'appareil a été exposé à la pluie ou à l'humidité, ou bien est tombé, ou encore ne fonctionne pas de manière normale.
15. Ne jamais exposer cet appareil à des risques de coulures ou d'éclaboussures de liquides ; ne jamais poser d'objets remplis de liquide – comme des vases, sur l'appareil.



Le symbole de l'éclair terminé par une pointe de flèche, dans un triangle équilatéral, est utilisé pour indiquer à l'utilisateur la présence d'une tension électrique potentiellement dangereuse, à l'intérieur de l'appareil, d'un niveau suffisamment élevé pour présenter des risques d'électrisation aux personnes physiques.



Le symbole du point d'exclamation, dans un triangle équilatéral, est utilisé pour indiquer à l'utilisateur, dans les manuels accompagnant l'appareil, la présence d'un point très important, concernant le fonctionnement ou la maintenance de l'appareil, à respecter impérativement.

**ATTENTION: POUR RÉDUIRE TOUT RISQUE D'ÉLECTROCUTION, NE JAMAIS EXPOSER CET APPAREIL À LA PLUIE OU L'HUMIDITÉ.**

	<b>ATTENTION</b> <b>RISQUE D'ÉLECTRISATION</b> <b>NE PAS OUVRIR</b>	
<p><b>ATTENTION :</b> AFIN DE RÉDUIRE LES RISQUES D'ÉLECTRISATION, NE JAMAIS ÔTER LE CAPOT DE L'APPAREIL. IL N'Y A À L'INTÉRIEUR AUCUNE PIÈCE SUSCEPTIBLE D'ÊTRE MODIFIÉE PAR L'UTILISATEUR. TOUJOURS FAIRE APPEL À UN TECHNICIEN AGRÉÉ.</p>		

**WARNING:** Any changes or modifications to this unit not expressly approved by the party responsible for compliance could void the user's authority to operate the equipment.

**NOTE:** This equipment has been tested and found to comply with the limits for a Class B digital device, pursuant to part 15 of the FCC Rules. These limits are designed to provide reasonable protection against harmful interference in a residential installation. This equipment generates, uses and can radiate radio frequency energy and, if not installed and used in accordance with the instructions, may cause harmful interference to radio communications. However, there is no guarantee that interference will not occur in a particular installation. If this equipment does cause harmful interference to radio or television reception, which can be determined by turning the equipment off and on, the user is encouraged to try to correct the interference by one or more of the following measures:

- Reorient or relocate the receiving antenna.
- Increase the separation between the equipment and receiver.
- Connect the equipment into an outlet on a circuit different from that to which the receiver is connected.
- Consult the dealer or an experienced radio/TV technician for help.

## Introduction

Thank you for purchasing the Sonance Sonamp 2-100 or 12-50 amplifier. When properly installed, this amplifier will give you many years of entertainment pleasure. To get the most out of your new amplifier, please read this manual thoroughly before you begin installation.

To achieve the best performance, Sonance recommends that this amplifier be installed by a Sonance Authorized Dealer/Installer.

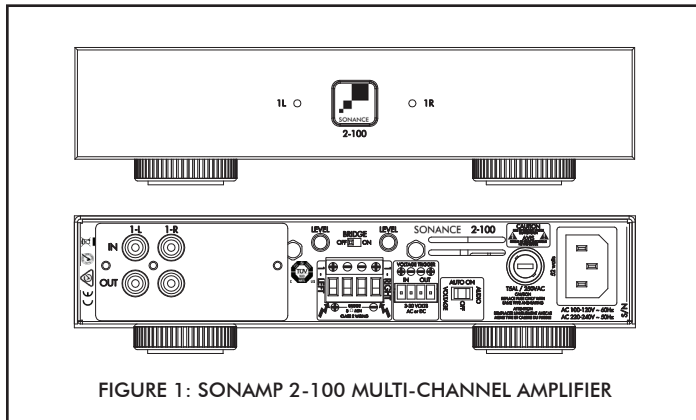

FIGURE 1: SONAMP 2-100 MULTI-CHANNEL AMPLIFIER

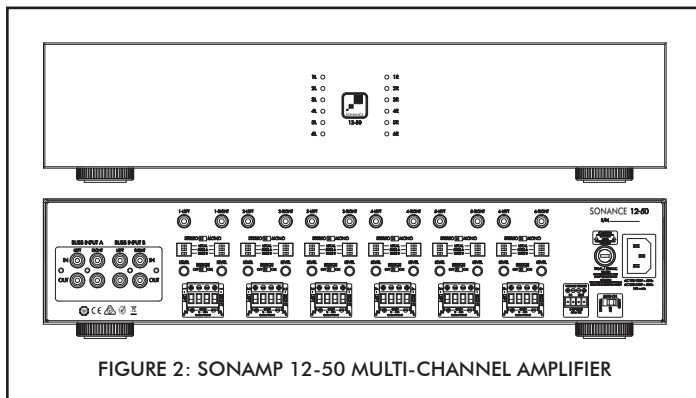

FIGURE 2: SONAMP 12-50 MULTI-CHANNEL AMPLIFIER

## Box Contents

### Your Sonamp 2-100 box should contain:

- (1) Instruction Manual
- (1) Sonamp 2-100 amplifier
- (1) IEC power cord
- (4) Feet
- (2) Long rack ears

### Your Sonamp 12-50 box should contain:

- (1) Instruction Manual
- (1) Sonamp 12-50 amplifier
- (1) IEC power cord
- (4) Feet
- (2) Rack ears

## Unpacking

Save the carton and polystyrene inserts for future safe transport in case the amplifier is moved or requires shipping for repair.

Before proceeding with installation, locate the serial number on the rear panel of the unit and note it here for future reference:

S/N: \_\_\_\_\_

## Placement

Place the amplifier on a level surface, in an upright position, out of direct sunlight and away from windows through which rain may enter.

Situate the amplifier away from heat sources such as hot air ducts or radiators. Be sure that the amplifier is adequately ventilated by convection or suitable cabinet fans.

- Never place any object on or against the amplifier.
- Never operate the amplifier on a carpeted surface as this will compromise ventilation.
- When the amplifier is installed in any cabinet, the front or back must be open during operation. Alternately, install fans in the cabinet to assure continuous ventilation.

FIGURE 3: SONAMP 2-100 MULTI-CHANNEL AMPLIFIER

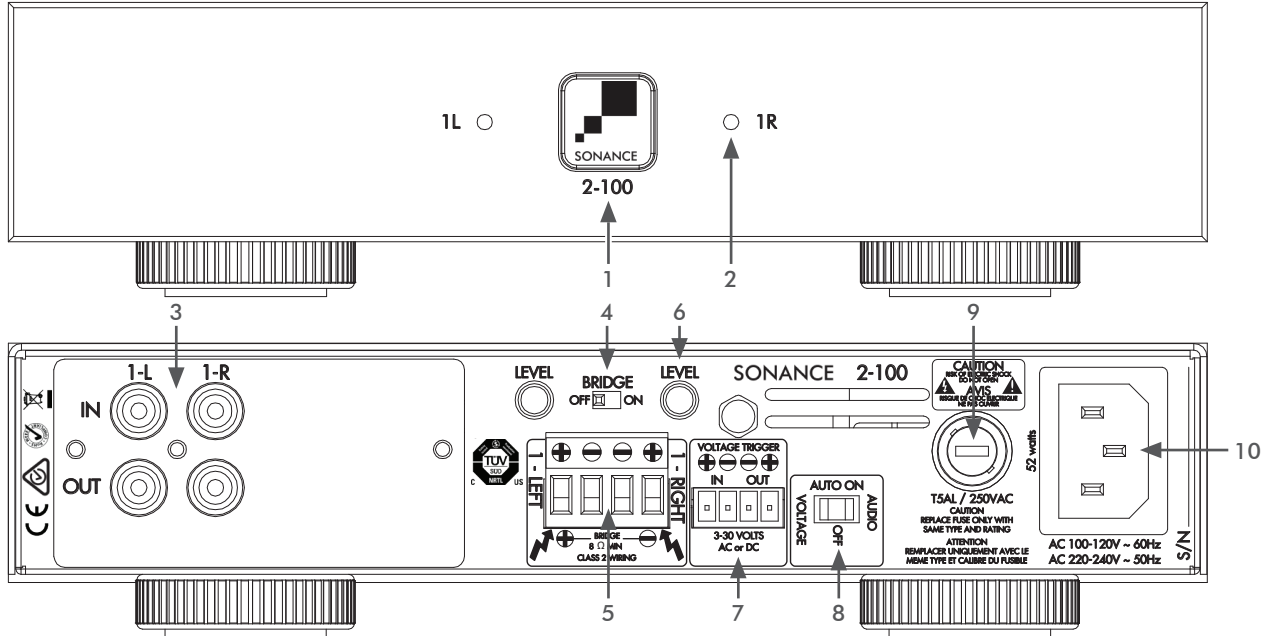

**2-100 FRONT PANEL**

- 1. Illuminated Power Button
- 2. Power, Active & Protection Indicator LED

**2-100 REAR PANEL**

- 3. L/R Line In/Loop Outputs
- 4. Bridging Switch
- 5. Speaker Block Connector
- 6. Volume Level Control
- 7. Trigger Input/Output Connector
- 8. Auto On Switch
- 9. AC Fuse Holder
- 10. Power Cord Connection

FIGURE 4: SONAMP 12-50 MULTI-CHANNEL AMPLIFIER

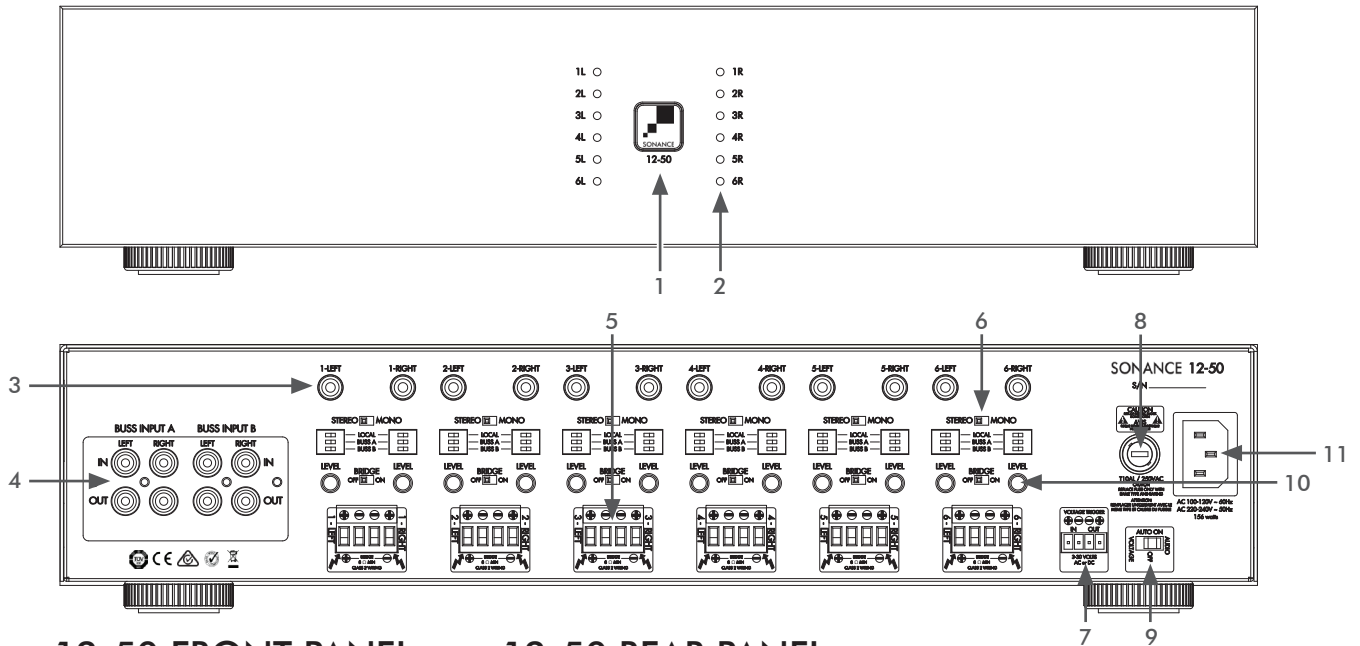

**12-50 FRONT PANEL**

- 1. Illuminated Power Button
- 2. Power, Active & Protection Indicator LED

**12-50 REAR PANEL**

- 3. LOCAL Line In Connectors
- 4. BUSS A/B Inputs/Loop Outputs
- 5. Speaker Block Connectors
- 6. Stereo/Mono, Buss Dip Switches
- 7. Trigger Input/Output Connector
- 8. AC Fuse Holder
- 9. Auto On Switch
- 10. Volume Level Control
- 11. Power Cord Connection

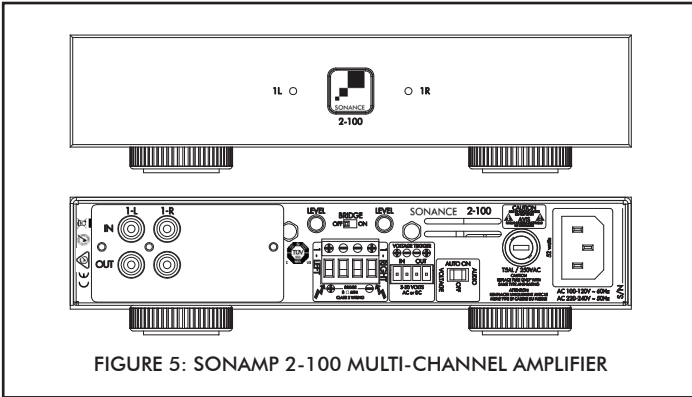

FIGURE 5: SONAMP 2-100 MULTI-CHANNEL AMPLIFIER

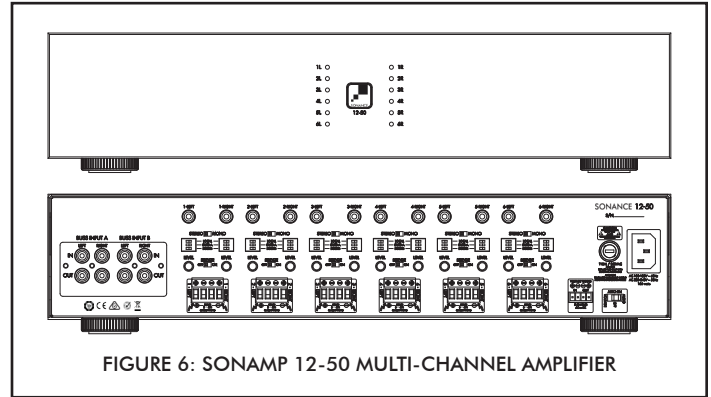

FIGURE 6: SONAMP 12-50 MULTI-CHANNEL AMPLIFIER

## Front Panel

### Power Switch

The power switch turns the amplifier on and off.

When the Sonance logo on the power switch is lit solid white, the amplifier has power and is turned ON and ready to operate.

When the Sonance logo is slightly dimmed the amplifier is in standby mode.

When the Sonance logo on the power switch is blinking white, the amplifier power supply is in thermal protection. The channel LEDs will also light red when the power supply is in thermal protect mode.

NOTE: Upon initial power up there will be an approximately 12 second boot up cycle. This is normal.

### Input/Output Lights

When each channel is active, the LED will light green as long as a signal is present.

When the LED blinks red, this is an indication that the channel is being overdriven.

When the LED lights are solid red this is an indication the amplifier is in protect mode. While in protect mode the LED lights will periodically light green to retest the output to determine if the short has been removed. Protect mode could be caused by a short in the wire, overheating of the amplifier or possibly an internal problem with the amplifier.

**NOTE: WHEN ANY OF THE LEDS ARE LIT RED TURN THE AMPLIFIER OFF IMMEDIATELY. DETERMINE THE CAUSE OF THE PROBLEM BEFORE TURNING THE AMPLIFIER ON.**

## Rear Panel

### Power Cord

The Sonamp amplifiers feature removable IEC power connectors. Plug the female end of the power cord into the Power Cord Connector on the amplifier rear panel and plug the male end into a grounded wall socket.

DO NOT plug the amplifier's power cord into a convenience outlet on any other audio or video component. If you need to use an extension cord, use only a heavy duty (14-GAUGE OR LARGER) extension cord to avoid starving the amplifier of the current necessary for full operation.

### AC Fuse Holder

To replace the fuse, unplug the power cord from the Power Cord Connector and use a screwdriver to remove the fuse holder.  
 2-100 - 5 amp AC (T5-AL)  
 12-50 - 10 amp AC (T10-AL)

**CAUTION: FOR CONTINUED PROTECTION AGAINST FIRE, REPLACE THE FUSE WITH ONLY THE SAME TYPE AND RATING.**

### Auto On - Voltage In/Out

The Sonamp amplifiers can be turned on and off using 3-30 volts AC or DC. The Voltage Output supplies a 12 volt DC signal to control additional amplifiers or other equipment.

### Volume Level Controls

Each channel on the amplifier has a volume adjustment pot accessible on the rear panel of the amplifier.

### Speaker Connections

The removable block connectors used on the Sonamp amplifiers will accept up to 12 gauge wire.

Follow the connection layout on the rear panel of the amplifier. Make sure no bare wires come in contact with the amplifier chassis. When bridging channels, use the two outside connections on each connector. The positive wire from the speaker should be on the left side connection and the negative connection should be on the right side.

### Line Inputs/Loop Outputs

The 2-100 amplifier has LINE INPUTS and loop OUTPUTS. The 12-50 amplifier has BUSS INPUTS A/B and loop OUTPUTS.

The loop outputs are non buffered, the maximum number of amplifiers that can be looped together will depend on the output capability of your source component.

## Powering the Amplifier

The Sonamp 2-100 & 12-50 features a removable IEC power connector (Figure 7). A 14-gauge EIA standard 120-volt grounded power cable is included with the amplifier. Due to the amplifier's power requirement, Sonance recommends that this cable not be replaced with another of unknown quality.

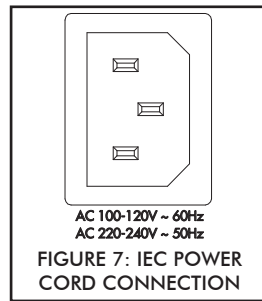

Each time the amplifier's power cord is initially plugged in and the POWER switch is turned ON, all channel outputs are disconnected for approximately 12 seconds and all PROTECTION LEDs will illuminate briefly while the amp boots up.

**IMPORTANT: DO NOT PLUG THE POWER CORD INTO THE WALL OUTLET UNTIL ALL SYSTEM CONNECTIONS HAVE BEEN MADE AND VERIFIED.**

Plug the female end of the power cable into the Power Connector on the amplifier's rear panel and plug the male end directly into a grounded 15 amp or 20 amp wall outlet.

**IMPORTANT: DO NOT PLUG THE AMPLIFIER'S POWER CORD INTO A CONVENIENCE OUTLET ON ANY OTHER AUDIO OR VIDEO COMPONENT.**

If the electrical service is subject to frequent sags, spikes, or brownouts, a power conditioner designed for use with high fidelity equipment should be employed to protect the amplifier.

**CAUTION: FOR CONTINUED PROTECTION AGAINST FIRE, REPLACE THE FUSE WITH ONLY THE SAME TYPE AND RATING.**

## Source Connections/Selection 12-50

There are three options when connecting audio inputs to the 12-50 amplifier:

**LOCAL Line In Connectors** - Use this input when you want the audio source to only come out of a specific channel (see Figure 9).

**Buss A Input** - Use this input when you want an audio source to be available to any of the 12 channels.

**Buss B Input** - Use this input when you want an audio source to be available to any of the 12 channels.

**Buss Loop Outputs** - Each of the Buss Inputs provide loop outputs to allow multiple amplifiers to share common audio sources. The loop outputs on the 12-50 amplifier are not buffered. The number of amplifiers that can be connected in series will depend on the output level of the audio source. The source connected to the LEFT and RIGHT LINE IN Inputs passes through to the LEFT and RIGHT LINE Outputs (see Figure 10). Always use high-quality interconnect cables.

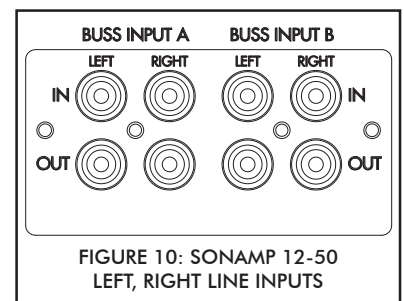
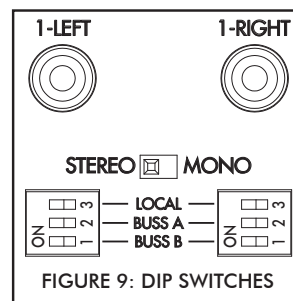

### Input Assignment DIP Switches

To assign an audio input to an output channel of the Sonamp 12-50 amplifier, select the audio input using the red dip switch. Audio inputs are selected by sliding the DIP switch ON (left) or OFF (right): (see Figure 9). You can select multiple inputs for each channel which could be used for paging or a doorbell as well as an audio source.

Amplifiers Power Requirements:				15 AMP Breaker	20 AMP Breaker
Model	Input Voltage	Output Power (sinewave)	Draw Watts	Qty of Amplifiers	Qty of Amplifiers
2-100	100-120V AC	Full Power All Channels @8 ohms	252	5	7
		Full Power All Channels @4 ohms	263	5	7
		1/8 Power All Channels @8 ohms	51	28	37
		1/8 Power All Channels @4 ohms	52	27	36
		@ Idle	22		
		@ Standby	0.3		
12-50	100-120V AC	Full Power All Channels @8 ohms	665	2	2
		Full Power All Channels @4 ohms	732	1	2
		1/8 Power All Channels @8 ohms	104	13	18
		1/8 Power All Channels @4 ohms	118	12	16
		@ Idle	30		
		@ Standby	0.36		
2-100	220-240V AC	Full Power All Channels @8 ohms	252	9	13
		Full Power All Channels @4 ohms	263	8	13
		1/8 Power All Channels @8 ohms	51	44	69
		1/8 Power All Channels @4 ohms	52	44	67
		@ Idle	20		
		@ Standby	0.3		
12-50	220-240V AC	Full Power All Channels @8 ohms	665	3	5
		Full Power All Channels @4 ohms	732	3	4
		1/8 Power All Channels @8 ohms	104	22	33
		1/8 Power All Channels @4 ohms	118	19	29
		@ Idle	30		
		@ Standby	0.45		

FIGURE 8: SONAMP 2-100 & 12-50 MULTI-CHANNEL AMPLIFIER POWER REQUIREMENTS



## Source Connections 2-100

On the left side of the 2-100 rear panel are the audio inputs for the left and right channels. In addition to the left and right inputs there are also loop outputs for each channel.

The loop outputs allow multiple amplifiers to share common audio sources. The loop outputs on the 2-100 amplifier are not buffered. The number of amplifiers that can be connected in series will depend on the output level of your audio source. The source connected to the LEFT and RIGHT LINE IN Inputs pass through the LEFT and RIGHT LINE Outputs (see Figure 11).

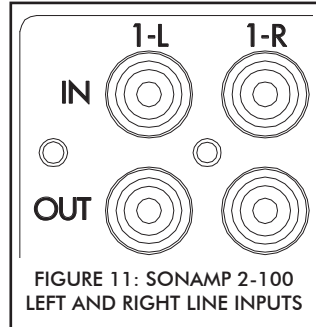

## Volume Level Controls 2-100 & 12-50

On the rear panel of both the 2-100 and 12-50 individual channel volume controls are provided (see Figure 12). These volume controls allow balancing the desired sound levels for various zones, or balancing the outputs from right and left channels to compensate for various room characteristics or seating arrangements. **The volume controls are set at 50%.**

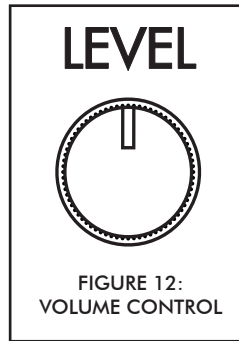

**IMPORTANT: USE CAUTION WHEN SETTING VOLUME LEVELS EITHER ON THE AMPLIFIER OR AN AUDIO SWITCHER AS NOT TO OVERDRIVE AND POSSIBLY DAMAGE SPEAKERS. VERIFY ALL SOURCES AS OUTPUT VOLTAGE VARIES FROM DEVICE TO DEVICE.**

## Speaker Connections

For the best sound you should use premium speaker wire, that complies with fire rating codes. Be sure to check local codes governing wire that may be installed within walls or ceilings. Sonamp amplifiers are stable with any reputable brand of speaker wire or cable. The Sonamp amplifiers use speaker block connectors that can accommodate up to 12 gauge wire (see Figure 13).

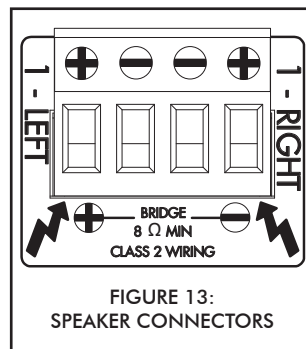

**NOTE: ALWAYS CHECK LOCAL BUILDING CODES BEFORE INSTALLING WIRE IN WALLS OR CEILINGS.**

## Bridging Channels 2-100 & 12-50

**IMPORTANT: THE MINIMUM SPEAKER IMPEDANCE FOR BRIDGED OPERATION IS 8 OHMS. DO NOT OPERATE A ZONE IN THE BRIDGED MODE INTO A SPEAKER THAT IS LESS THAN 8 OHMS NOMINAL IMPEDANCE.**

1. Set the zone's BRIDGE switch to the ON position (see Figure 14).
2. Connect the speaker's "+" lead to the left side of the connector marked "+" (see Figure 15).
3. Connect the speaker's "-" lead to the right side of the connector marked "+" (see Figure 15).

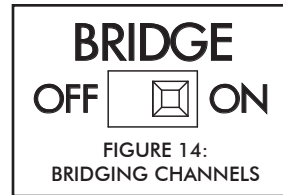

### 2-100

Use the left audio input when operating the amplifiers output in bridged mode.

### 12-50

Use the left LOCAL Input or the left Buss Input when operating the amplifiers output in bridged mode. Use the DIP switch to select the input you would like to assign to the bridged output.

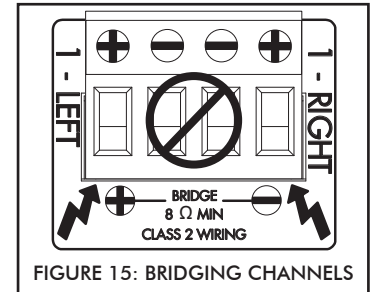

## Trigger Mode Control 2-100 & 12-50

You can set the Sonamp amplifiers so that they will automatically turn ON when it receives an audio signal, when it receives a control voltage from an external source, or to remain on and not enter standby.

**NOTE: IF EITHER AUDIO OR VOLTAGE TRIGGERS ARE SELECTED, THE AMPLIFIER HAS A 12 SECOND CYCLE TIME FROM STANDBY TO PLAY AN AUDIO SIGNAL. THIS IS NORMAL AND REQUIRED TO COMPLY WITH THE EU < .5 WATT ErP DIRECTIVE. (EC/1275/2008). SELECT OFF TO BYPASS THIS FEATURE. SEE POWER CONSUMPTION TABLE FOR IDLE POWER USE (SEE FIGURE 7).**

### Auto On Triggering - Three Position Switch

#### AUDIO

In this mode, the amplifier will automatically turn ON when the minimum audio signal of 2.5 mV is detected at any of the inputs (Buss or LOCAL on the 12-50). This takes 12 seconds. The amplifier will turn OFF after 15 minutes of no input signal on any of the inputs.

#### VOLTAGE

When AUTO ON switch is in the left position, power will only turn on with a VOLTAGE of 3 to 30 volts AC or DC. Connect the trigger voltage source to the input of the voltage trigger using the left side of the green block connector. This takes 12 seconds.

#### OFF

When AUTO ON switch is in the center position, OFF, the amplifier will remain ON and will not go into standby mode.

**NOTE: WHEN THE AUTO ON SWITCH IS SET TO OFF THE AMPLIFIERS POWER SAVING FEATURE WILL BE DISABLED.**

#### 12V Trigger Output

The Sonamp has a 12V OUTPUT 2-wire screw connector found on the right side of the green block connector that provides 12V DC whenever the amplifier is ON.

**NOTE: THE CURRENT DRAW ON THE 12V TRIGGER OUTPUT CONNECTION SHOULD NOT EXCEED 200mA.**



## Protection Circuitry and LEDs

The Sonamp amplifiers have a multi-stage protection system to prevent damage to your amplifier and speakers.

### Amplifier Channel Protection 2-100 & 12-50

If a channel encounters a short-circuit (in bridged mode the protection circuitry will sense a short circuit across both positive speaker terminals), or extremely low impedance will cause the affected channel outputs to automatically mute. The output of the effected channel will remain muted until the fault has been corrected. Only the effected channels output will mute, all other channels will continue to operate normally.

### Amplifier Channel Protection Indication 2-100 & 12-50

On the front panel of the Sonamp 2-100 and 12-50 amplifiers are dual color LEDs that illuminate to indicate the current operating status of each amplifier channel.

When the LED blinks red this is an indication that the channel is being overdriven.

When the LED lights are solid red this is an indication the amplifier is in protect mode. While in protect mode the LED lights will periodically light green to retest the output to determine if the short has been removed. Protect mode could be caused by a short in the wire, overheating of the amplifier or possibly an internal problem with the amplifier.

**IMPORTANT: ALLOWING THE AMPLIFIER TO OPERATE WITH ONE OR MORE CHANNELS IN PROTECT MODE FOR AN EXTENDED PERIOD OF TIME CAN DAMAGE THE AMPLIFIER.**

### Amplifier Power Supply Protection 2-100 & 12-50

The amplifier also has protection for the power supply. If the power supply heat sink temperature exceeds the design maximum, the protection circuit will activate, disconnecting all channel outputs. This is indicated by a blinking light on the front panel power switch.

**IMPORTANT: ANY TIME THE PROTECTION CIRCUITS ARE TRIGGERED, UNPLUG THE AMPLIFIER'S POWER CORD FROM THE WALL OUTLET BEFORE TROUBLESHOOTING.**

## Rack Ear Installation 2-100

The 2-100 ships with two long rack ears for when the amplifier is to be used alone in a 1U space. Unscrew the four Phillips head screws found on each side of the left and right forward section of amplifier. Use these screws to connect the included rack ears to the amplifier (see Figure 16).

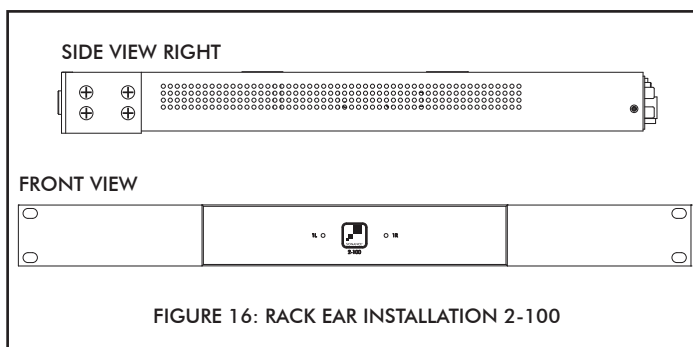

## Rack Ear Installation 12-50

The 12-50 ships with two short rack ears. Unscrew the four Phillips head screws found on each side of the left and right forward section of amplifier. Use these screws to connect the included rack ears to the amplifier (see Figure 17).

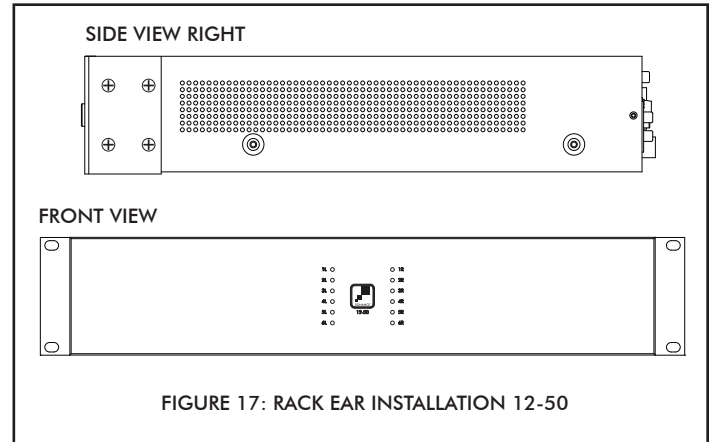

## Amplifier Stacking

The 2-100 & 12-50 are capable of being directly stacked with the feet removed (see Figure 18) for use in low to moderate output applications. For high-output applications, it is recommended to leave at least 1U space between amplifiers for increased ventilation.

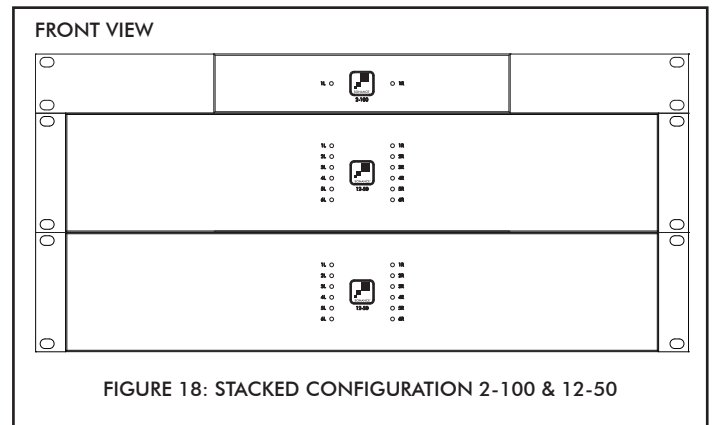

To place two Sonamp 2-100 or DSP 2-150 in a single rack unit order RACK MOUNT BRACKET FOR SONAMP 2-100 & DSP 2-150 SKU#93098 (see Figure 19).

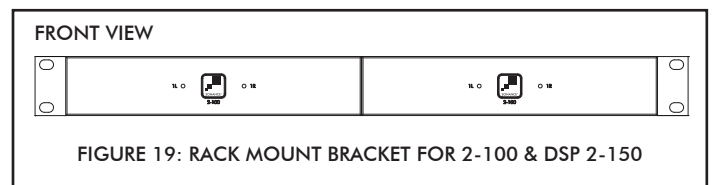

## Shelf Mounting

If shelf mounting, attach the four included feet by screwing them into the threaded openings, no tool is required.

## SPECIFICATIONS

### SONAMP 2-100

Number of Channels	2 (1 stereo pair)
Power Output - 8 ohms (Stereo)	100 Watts RMS per channel (all channels driven)
Power Output - 4 ohms (Stereo)	156 Watts RMS per channel (all channels driven)
Power Output - 8 ohms (Bridged)	325 Watts
Frequency Response	5Hz – 50kHz, bandwidth limited
Total Harmonic Distortion	0.15% (1kHz, 8 ohms) 0.1% (1kHz, 4 ohms)
Signal to Noise Ratio	-100dB (20-20kHz)
Input Gain	29dB
Input Sensitivity	100mV for 1W Output @8 ohms 990mV for 100W Output @8 ohms
Input Impedance	36k ohms
Loop Output Impedance	600 ohms (non-buffered)
Maximum Source Input Voltage	7.3 VAC RMS
AC Power Consumption 120V	
@ 8 ohms (sinewave, full power)	252 Watts, 120V
@ 4 ohms (sinewave, full power)	263 Watts, 120V
@ 8 ohms (sinewave, 1/8 power)	51 Watts, 120V
@ 4 ohms (sinewave, 1/8 power)	52 Watts, 120V
@ idle	22 Watts, 120V
@ standby	0.3 Watts, 120V
AC Power Consumption 220V	
@ 8 ohms (sinewave, full power)	241 Watts, 220V
@ 4 ohms (sinewave, full power)	253 Watts, 220V
@ 8 ohms (sinewave, 1/8 power)	48 Watts, 220V
@ 4 ohms (sinewave, 1/8 power)	49 Watts, 220V
@ idle	20 Watts, 220V
@ standby	0.3 Watts, 220V
Heat Output	
BTU/HR into 8 ohms	152 BTU, Full Rated Power all channels driven
BTU/HR into 4 ohms	185 BTU, Full Rated Power all channels driven
BTU/HR into 8 ohms	84 BTU, 1/8 power all channels driven
BTU/HR into 4 ohms	92 BTU, 1/8 power all channels driven
AC Voltage	100-120V@60Hz, 220-240V@50Hz
AC Fuse	5A (T5AL ~ 250V)
Rack Space Requirement	1U – 1/2 Rack Width
Dimensions w/ Feet (W x H x D)	8 5/8" x 2 1/8" x 16 13/16" (219mm x 54mm x 427mm)
Dimensions w/ Rack Ears w/o Feet (W x H x D)	19" x 1 3/4" x 16 13/16" (482mm x 44mm x 427mm)
Shipping Weight	10 lbs (4.53kg)



CAD Files available for download at [www.sonance.com/electronics/amplifiers](http://www.sonance.com/electronics/amplifiers)

## SPECIFICATIONS

### SONAMP 12-50

Number of Channels	12 (6 stereo pairs)
Power Output - 8 ohms (Stereo)	50 Watts RMS per channel (all channels driven)
Power Output - 4 ohms (Stereo)	50 Watts RMS per channel (all channels driven)
Power Output - 8 ohms (Bridged)	100 Watts
Frequency Response	5Hz – 50kHz, bandwidth limited
Total Harmonic Distortion	0.05% (1kHz, 8 ohms) 0.1% (1kHz, 4 ohms)
Signal to Noise Ratio	-87dB (20-20kHz)
Input Gain	29dB
Input Sensitivity	100mV for 1W Output @8 ohms 650mV for 50W Output @8 ohms
Input Impedance	33k ohms
Loop Output Impedance	600 ohms (non-buffered)
Maximum Source Input Voltage	3.2 VAC RMS
AC Power Consumption 120V	
@ 8 ohms (sinewave, full power)	665 Watts, 120V
@ 4 ohms (sinewave, full power)	732 Watts, 120V
@ 8 ohms (sinewave, 1/8 power)	104 Watts, 120V
@ 4 ohms (sinewave, 1/8 power)	118 Watts, 120V
@ idle	30 Watts, 120V
@ standby	0.36 Watts, 120V
AC Power Consumption 220V	
@ 8 ohms (sinewave, full power)	617 Watts, 220V
@ 4 ohms (sinewave, full power)	624 Watts, 220V
@ 8 ohms (sinewave, 1/8 power)	100 Watts, 220V
@ 4 ohms (sinewave, 1/8 power)	108 Watts, 220V
@ idle	30 Watts, 220V
@ standby	0.45 Watts, 220V
Heat Output	
BTU/HR into 8 ohms	614 BTU, Full Rated Power all channels driven
BTU/HR into 4 ohms	624 BTU, Full Rated Power all channels driven
BTU/HR into 8 ohms	80 BTU, 1/8 power all channels driven
BTU/HR into 4 ohms	139 BTU, 1/8 power all channels driven
AC Voltage	100-120V@60Hz, 220-240V@50Hz
AC Fuse	10A (T10AL ~ 250V)
Rack Space Requirement	2U
Dimensions w/ Feet (W x H x D)	17 1/4" x 3 7/8" x 16 13/16" (438mm x 98mm x 427mm)
Dimensions w/ Rack Ears w/o Feet (W x H x D)	19" x 3 1/2" x 16 13/16" (482mm x 88mm x 427mm)
Shipping Weight	20 lbs (9.07kg)



CAD Files available for download at [www.sonance.com/electronics/amplifiers](http://www.sonance.com/electronics/amplifiers)

## LIMITED TWO (2) YEAR WARRANTY

Sonance warrants to the first end-user purchaser that this Sonance-brand product ("Product"), when purchased from an authorized Sonance Dealer/Distributor, will be free from defective workmanship and materials for the period stated below. Sonance will at its option and expense during the warranty period, either repair the defect or replace the Product with a new or remanufactured Product or a reasonable equivalent.

## EXCLUSIONS

TO THE EXTENT PERMITTED BY LAW, THE WARRANTY SET FORTH ABOVE IS IN LIEU OF, AND EXCLUSIVE OF, ALL OTHER WARRANTIES, EXPRESS OR IMPLIED, AND IS THE SOLE AND EXCLUSIVE WARRANTY PROVIDED BY SONANCE. ALL OTHER EXPRESS AND IMPLIED WARRANTIES, INCLUDING THE IMPLIED WARRANTIES OF MERCHANTABILITY, IMPLIED WARRANTY OF FITNESS FOR USE, AND IMPLIED WARRANTY OF FITNESS FOR A PARTICULAR PURPOSE ARE SPECIFICALLY EXCLUDED.

No one is authorized to make or modify any warranties on behalf of Sonance. The warranty stated above is the sole and exclusive remedy and Sonance's performance shall constitute full and final satisfaction of all obligations, liabilities and claims with respect to the Product.

IN ANY EVENT, SONANCE SHALL NOT BE LIABLE FOR CONSEQUENTIAL, INCIDENTAL, ECONOMIC, PROPERTY, BODILY INJURY, OR PERSONAL INJURY DAMAGES ARISING FROM THE PRODUCT, ANY BREACH OF THIS WARRANTY OR OTHERWISE.

This warranty statement gives you specific legal rights, and you may have other rights which vary from state to state. Some states do not allow the exclusion of implied warranties or limitations of remedies, so the above exclusions and limitations may not apply. If your state does not allow disclaimer of implied warranties, the duration of such implied warranties is limited to period of Sonance's express warranty.

Your Product Model and Description: Sonamp 2-100 & Sonamp 12-50 Multi-Channel Power Amplifiers

Warranty Period for this Product: Two (2) years from the date on the original sales receipt or invoice or other satisfactory proof of purchase.

Additional Limitations and Exclusions from Warranty Coverage: The warranty described above is non-transferable, applies only to the initial installation of the Product, does not include installation of any repaired or replaced Product, does not include damage to allied or associated equipment which may result for any reason from use with this Product, and does not include labor or parts caused by accident, disaster, negligence, improper installation, misuse (e.g. overdriving the amplifier or speaker, excessive heat, cold or humidity), or from service or repair which has not been authorized by Sonance. Obtaining Authorized Service: To qualify for the warranty, you must contact your authorized Sonance Dealer/Installer or call Sonance Customer Service at (949) 492-7777 within the warranty period, must obtain a return merchandise number (RMA), and must deliver the Product to Sonance shipping prepaid during the warranty period, together with the original sales receipt, or invoice or other satisfactory proof of purchase.



©2014 Sonance. All rights reserved. Sonance and Sonamp are registered trademarks of Dana Innovations.

Due to continuous product improvement, all features and specifications are subject to change without notice.  
For the latest Sonance product specification information visit our website: [www.sonance.com](http://www.sonance.com)

SONANCE • 212 Avenida Fabricante • San Clemente, CA 92672-7531 USA  
(949) 492-7777 • FAX: (949) 361-5151 • Technical Support: (949) 492-7777

[www.sonance.com](http://www.sonance.com)